

European Community Design Registration RCD 000929971

Bin
50 Litre

B1

Elevation
Design

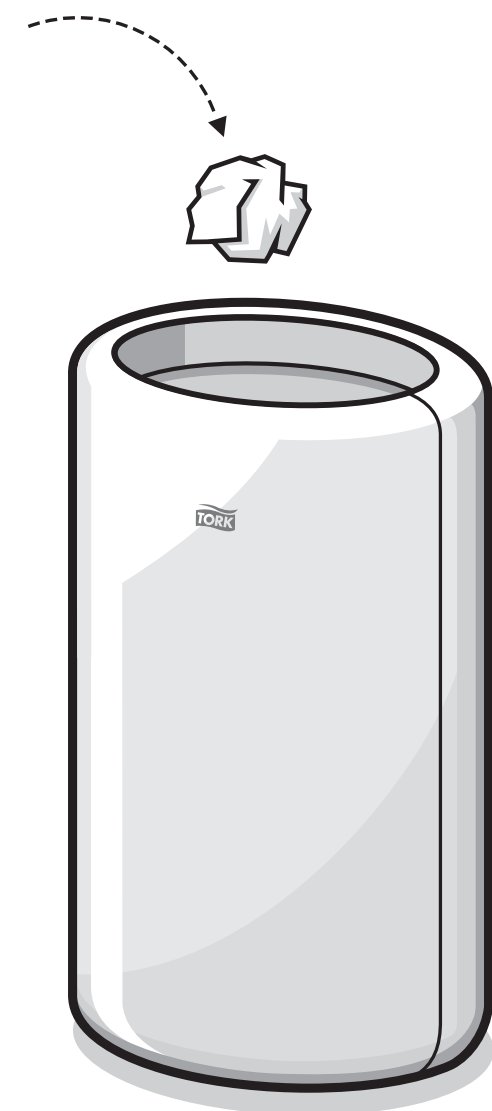

 **essity** Manufactured by Essity Hygiene and Health AB
SE-40503 Göteborg, Sweden
Visiting address: Mölndals Bro 2, Mölndal
www.essity.com, www.torkglobal.com
Made in Germany
Patents/Brevets/Patentes: www.essity.com/patents

www.torkglobal.com

TORK

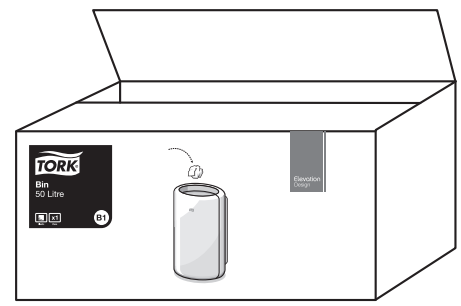

+

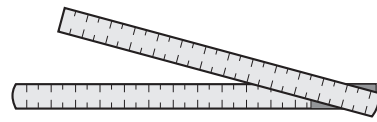
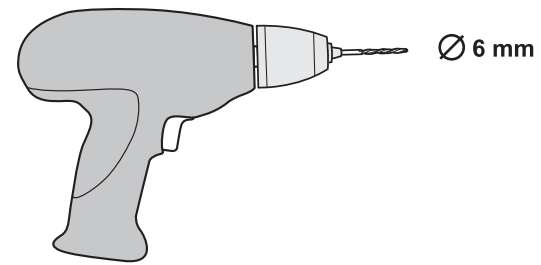
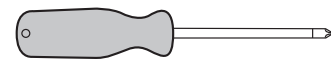
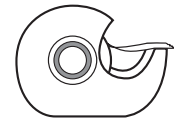

5.

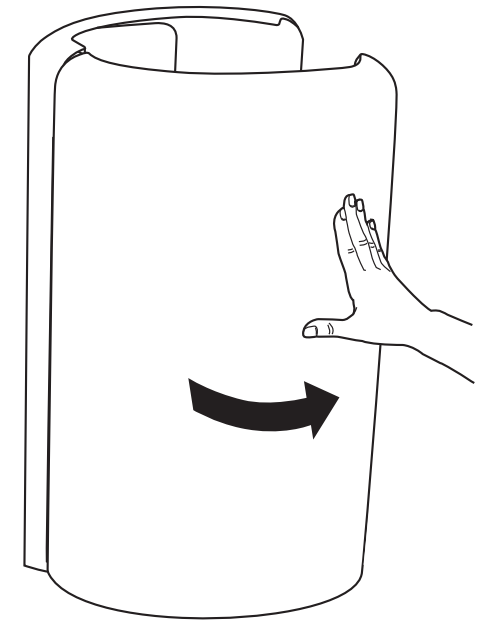

6.

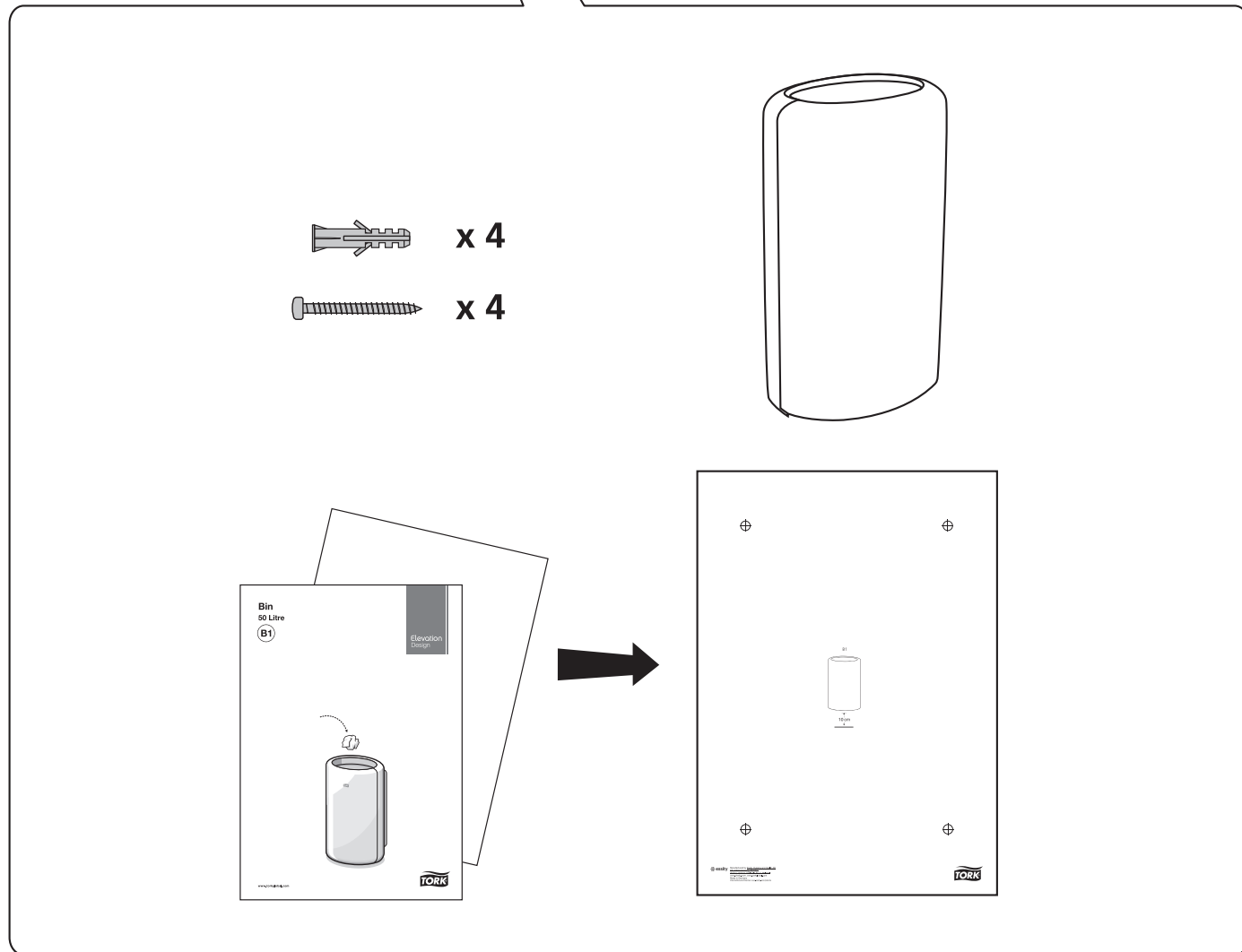
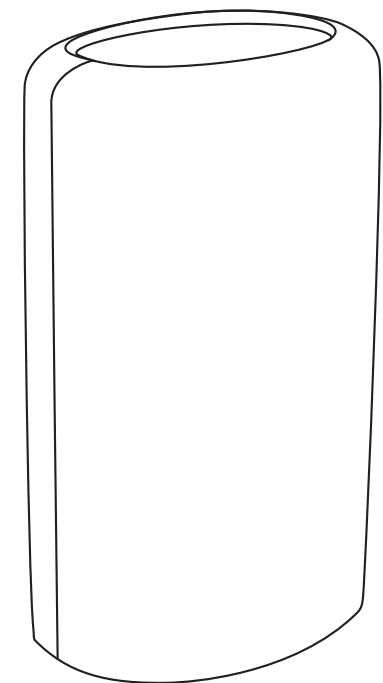

2.

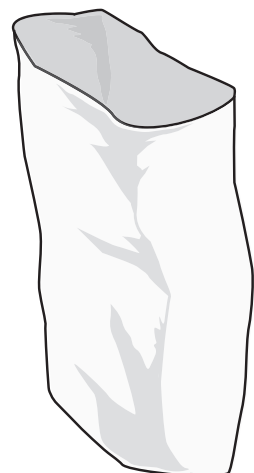
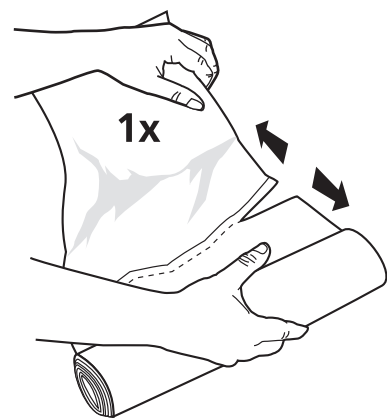

3.



4.

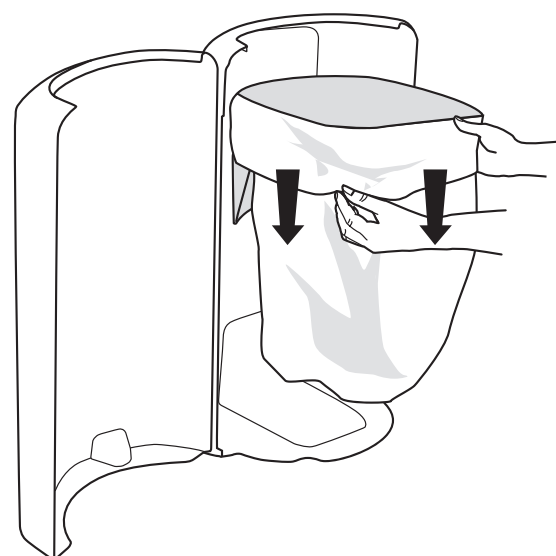

A

B

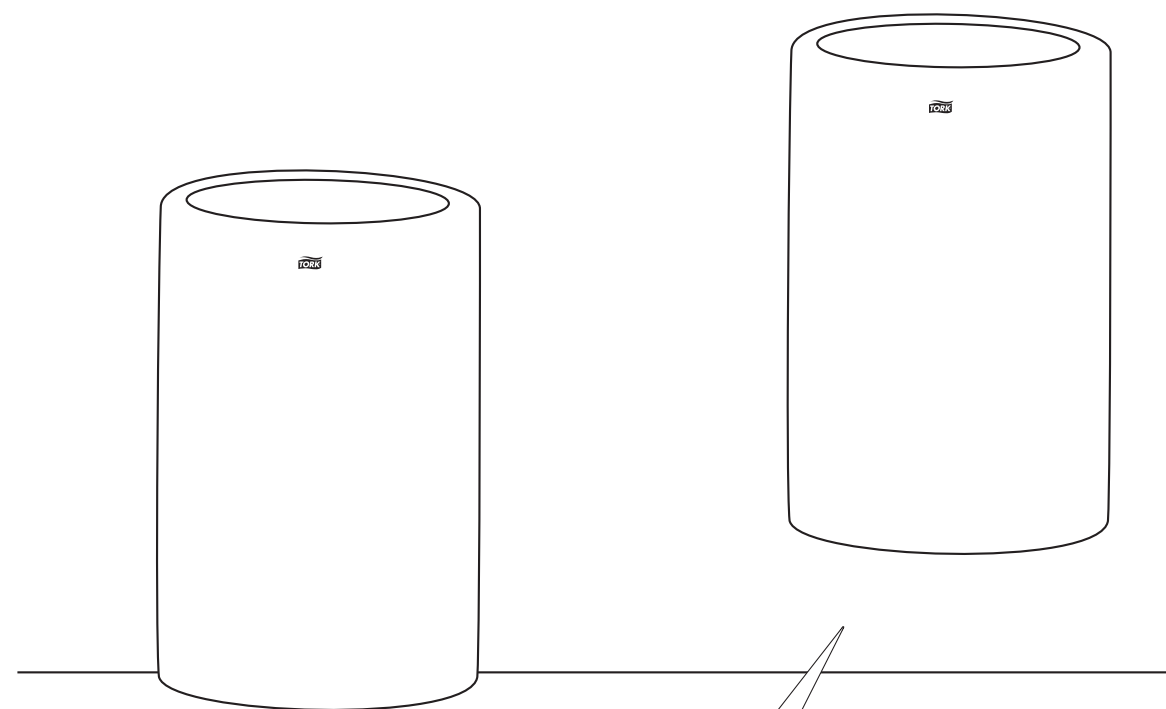

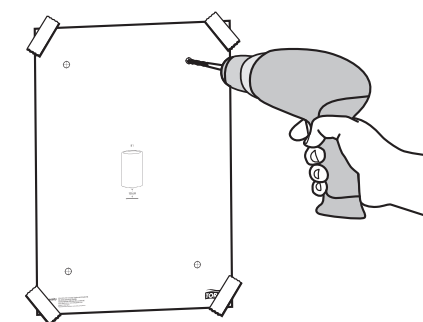
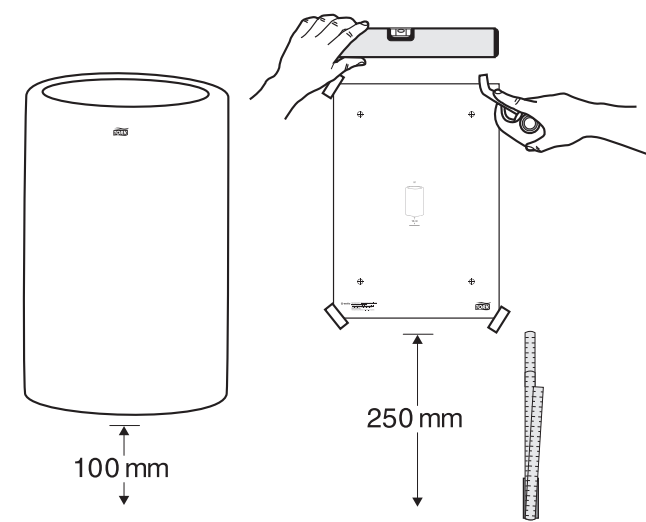

1.

2.

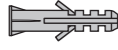

3.

-  x 4
-  x 4

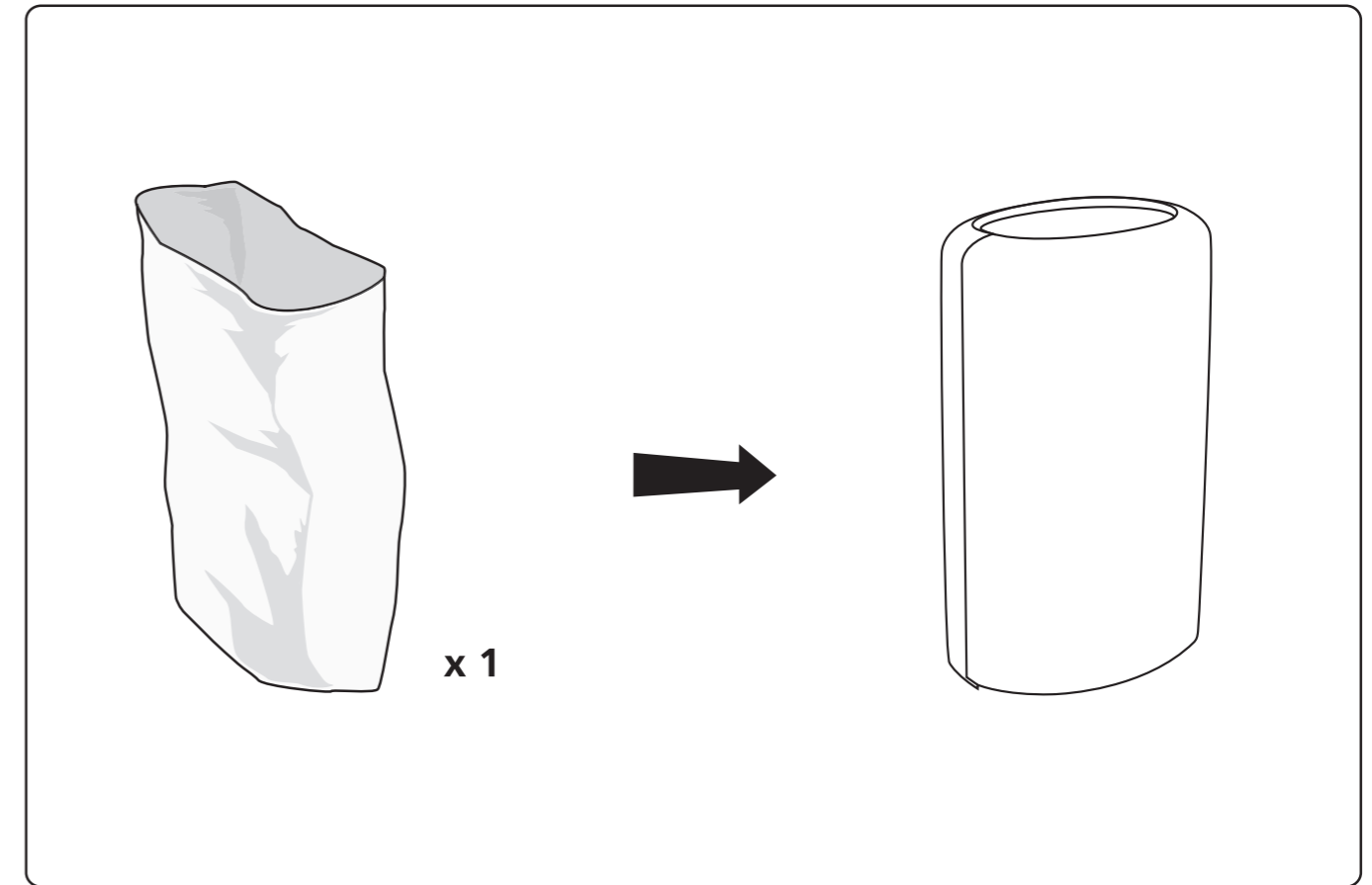
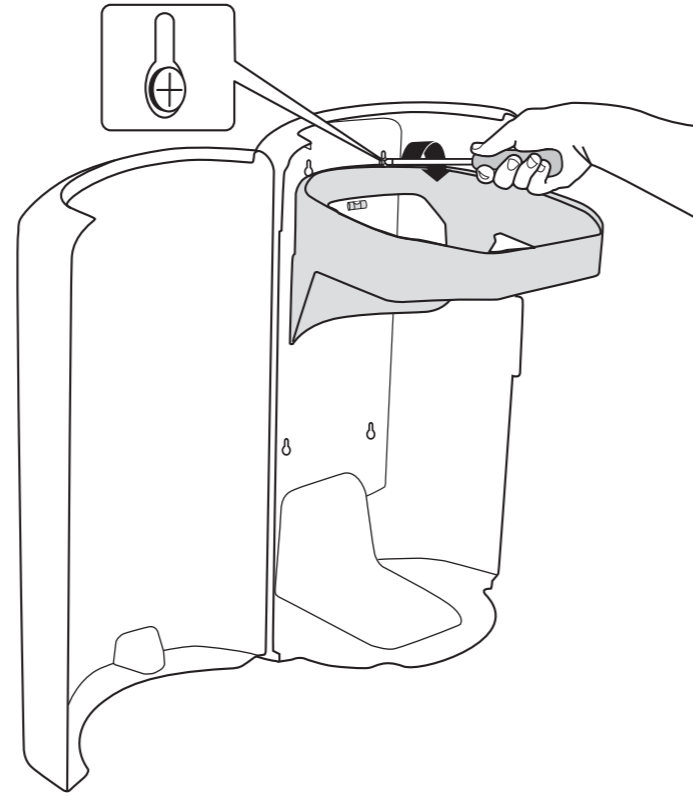

4.

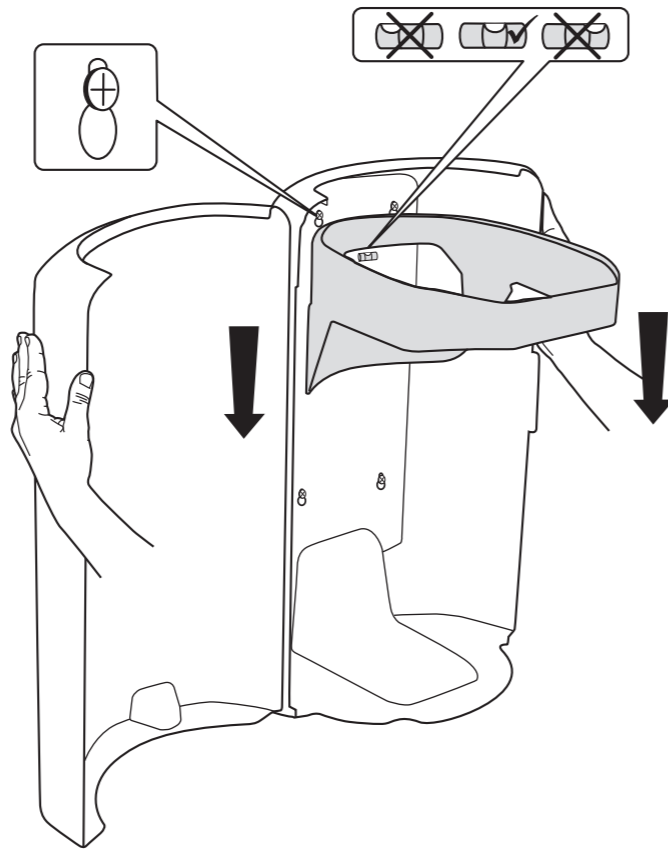

1.

